

400 mm Hollowcore – Self weight 0,471 T/m²

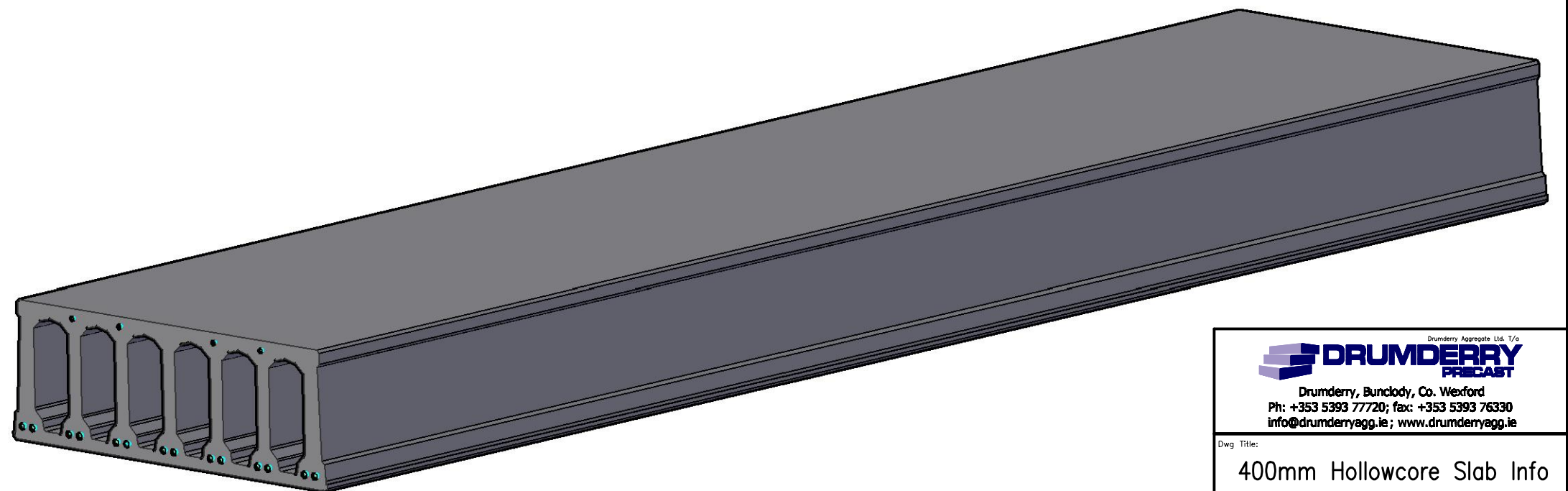

Drumderry, Bunclody, Co. Wexford
 Ph: +353 5393 77720; fax: +353 5393 76330
 info@drumderryagg.ie; www.drumderryagg.ie

Dwg Title:
400mm Hollowcore Slab Info

Scale: N/A Date: 3/10/2008 Drawn by: K.S.

Drawings, Specifications, Design Calculations & Measurements supplied by Drumderry Precast/Drumderry Aggregate Ltd. are copyright and shall not be used, copied or issued to third parties for the purposes of design or procurement of alternative quotations except with the written consent of Drumderry Precast/Drumderry Aggregate Ltd.